



14, rue de l'atome  
67800 Bischheim, France  
Tel. +33 (0)3 90 22 74 00 • Fax. +33 (0)3 90 20 09 12  
[www.hjchelmets.com](http://www.hjchelmets.com)

If you have any questions, please email us at: [info@hjc-europe.com](mailto:info@hjc-europe.com)  
Pour plus d'information, nous contacter á [info@hjc-europe.com](mailto:info@hjc-europe.com)  
Wenn sie dazu Fragen haben, senden Sie bitte eine E-Mail an: [info@hjc-europe.com](mailto:info@hjc-europe.com) / [info@hjc-germany.de](mailto:info@hjc-germany.de)  
Si tiene alguna pregunta, envíenos un correo electrónico a: [info@hjc-europe.com](mailto:info@hjc-europe.com)  
Se avete delle domande, inviateci un'email a: [info@hjc-europe.com](mailto:info@hjc-europe.com)  
Indien u vragen heeft kunt u via het volgende e-mail adres contact met ons opnemen: [info@hjc-europe.com](mailto:info@hjc-europe.com)

**HJC VINA LIMITED COMPANY**  
Made In Vietnam • Fabriqué au Vietnam • Hergestellt in Vietnam  
Hecho en Vietnam • Fabricato in Vietnam

Rev.01



# CL-SP

## OWNER'S MANUAL

### **⚠ WARNING**

For your safety, it is important that you completely read the owner's manual and all warning labels.

Pour votre sécurité, il est important que vous lisiez intégralement le manuel du propriétaire ainsi que tous les points d'avertissements.

Im Interesse Ihrer eigenen Sicherheit empfehlen wir Ihnen, diese Benutzerhinweise und alle Sicherheitsetiketten sorgfältig und vollständig zu lesen.

Para su seguridad, es importante que vd.,lea completamente el manual y todas las etiquetas de advertencias.

Per la tua sicurezza è importante che tu legga interamente ed attentamente questo manuale d'uso.

Het is van belang voor uw eigen veiligheid dat u de handleiding en alle waarschuwingen volledig leest.

## English / Français

Important Safety Information / Informations importantes relatives à la sécurité .....	3 / 11
Selecting the Right Helmet / Choisir le bon casque .....	3-4 / 11-12
Specifications / Caractéristiques .....	4 / 12
Using Your Helmet Correctly / Utilisation correcte du casque .....	5-6 / 13-14
Inspect Your Helmet / Contrôle du casque .....	5 / 13
Fasten the Retention System / Serrage du système d'attache .....	5-6 / 13-14
Maintaining Your Helmet Correctly / Entretien correct du casque .....	6-9 / 14-17
Shell Cleaning / Nettoyage de la coque .....	6 / 14
Interior Cleaning / Nettoyage de l'intérieur .....	6 / 14
Vent Cleaning / Nettoyage de la ventilation .....	6 / 14
Shield Removal / Démontage de l'écran .....	7 / 15
Shield Installation / Installation de l'écran .....	7 / 15
Cheek Pad Removal / Démontage mousse joue .....	8 / 16
Cheek Pad Installation / Installation mousse joue .....	8 / 16
Crown Pad Removal / Démontage garniture intérieure .....	8 / 16
Crown Pad Installation / Installation de la garniture intérieure .....	9 / 17
Replacement Parts / Remplacement des pièces .....	9 / 17
Helmet Modifications / Modifications du casque .....	9 / 17
Storing Your Helmet Correctly / Rangez soigneusement le casque .....	9 / 17
Helmet Replacement / Remplacement du casque .....	10 / 18
Warranty / Garantie .....	10 / 18

## Deutsch / Español

Wichtige Sicherheitsinformationen / Información de Seguridad Importante .....	19 / 27
Helmauswahl / Seleccionar un Casco Correcto .....	19-20 / 27-28
Eigenschaften / Especificaciones .....	20 / 28
Richtige Benutzung des Helmes / Empleo correcto del casco .....	21-22 / 29-30
Sicherheitsprüfung des Helmes / Inspección el casco .....	21 / 29
Schließen des Kinnriemens / Ajuste del sistema de retención .....	21-22 / 29-30
Richtige Wartung/Pflege Ihres Helmes / Mantenimiento correcto del casco .....	22-25 / 30-33
Reinigen der Aussenschale / Limpieza del armazón .....	22 / 30
Reinigen des Innenfutters / Limpieza interna .....	22 / 30
Reinigen der Belüftungen / Limpieza de la ventilación .....	22 / 30
Visierdemontage / La pantalla: como quitarla .....	23 / 31
Visiermontage / Como instalar la pantalla .....	23 / 31
Demontage Wangenpolster / Extracción de la almohadilla de la mejilla .....	24 / 32
Montage Wangenpolster / Instalación de la almohadilla de la mejilla .....	24 / 32
Kopfpolster Demontage / Extracción de la almohadilla de la cabeza .....	24 / 32
Kopfpolster Montage / Instalación de la almohadilla de la cabeza .....	25 / 33
Ersatzteile / Repuestos .....	25 / 33
Helmmodifikationen / Modificaciones del casco .....	25 / 33
Richtige Aufbewahrung/Lagerung Ihres Helmes / Almacenamiento correcto del casco .....	25 / 33
Austausch Ihres Helmes / Reemplazo del casco .....	26 / 34
Gewährleistung / Garantía .....	26 / 34

## Italian / Dutch

Importanti informazioni di sicurezza / Belangrijke Veiligheidsinformatie .....	35 / 43
Scegliere il giusto casco / De juiste Helm selecteren .....	35-36 / 43-44
Caratteristiche / Specificaties .....	36 / 44
Usare il vostro casco correttamente / Uw helm op juiste wijze gebruiken .....	37-38 / 45-46
Inspezionare il vostro casco / Inspecteer uw helm .....	37 / 45
Allacciare il sistema di bloccaggio / Bevestig het retentiesysteem .....	37-38 / 45-46
Manutenzione corretta del vostro casco / Uw helm op juiste wijze onderhouden .....	38-41 / 46-49
Pulizia della calotta / Bevestiging van schaal .....	38 / 46
Pulizia dell'interno / Schoonmaken van het interieur .....	38 / 46
Pulizia del foro di aerazione / Schoonmaken van de ventilatiesleuven .....	38 / 46
Rimozione della visiera / Verwijderen van het vizier .....	39 / 47
Installazione della visiera / Monteren van het vizier .....	39 / 47
Rimozione dei guanciali / Wangkussentje losmaken .....	40 / 48
Installazione del guanciaie / Installatie wangkussentje .....	40 / 48
Rimozione dell'imbottitura a corona / Losmaken van het middenkussentje .....	40 / 48
Installazione dell'imbottitura a corona / Installatie van het middenkussentje .....	41 / 49
Parti di ricambio / Vervangingsonderdelen .....	41 / 49
Allacciare il sistema di ritenzione / Helmaanpassingen .....	41 / 49
Alloggiare il vostro casco correttamente / Correcte opslag van de helm .....	41 / 49
Sostituzione del casco / Vervangen van de helm .....	42 / 50
Garanzia / Garantie .....	42 / 50

## ⓘ Important Safety Information

### ⚠ WARNING

The instructions in this manual are designed to help you select the right helmet, wear it properly, take care of it, and know when to replace it. Failure to follow these instructions may increase your risk of serious injury or death in an accident.

In order to get the most protection possible from your helmet, you should always do the following:

- Wear your helmet when you ride;
- Handle your helmet carefully to avoid accidental damage; and
- Ride safely – do not take risks because you are wearing a helmet.

Although your HJC helmet is designed to reduce or prevent some injuries when worn, no helmet can protect you from all possible or foreseeable impacts. For example, your helmet cannot protect you from spinal or neck injuries. In addition, there is no guarantee that your helmet will PREVENT injuries to the area of your head that is covered. A low speed accident may even result in serious injury or death.

## ⓘ Selecting the Right Helmet

**⚠ WARNING** Never buy a used helmet or borrow someone else's helmet. Over time the protective foam in helmets will adjust to the contours of a user's head. A used or borrowed helmet may not offer as much protection as a new helmet.

**⚠ WARNING** Wearing the wrong size helmet can increase your risk of serious injury or death in an accident. A helmet that is too large for your head may be dislodged or knocked off in an accident. To select the right size helmet for your head, follow these instructions:

1. **Measure your head.** Wrap a tape measure around your head about one inch (2.5 cm) above your eyebrows.
2. **Use the sizing chart** to select the helmet size that corresponds most closely to your head measurement. If your head size falls between two helmet sizes, try on the larger helmet first and then the smaller size.

### Sizing Chart

	3XL	4XL
Hat Size	8 1/8 - 8 1/4	8 3/8 - 8 1/2
Centimeter	65-66	67-68
Inch	25 5/8 - 26	26 3/8 - 26 7/8

### ⚠ WARNING

The size chart is only for reference. Always try the helmet on and follow this manual's instructions for a proper fit.

3. **Try on the helmet** by grasping both chin straps to pull the helmet completely onto your head, ensuring that the top of your head is in contact with the top of the helmet interior.
4. **Check for a proper fit.** To make sure your helmet is the right size, check that:
  - The helmet inner lining fits snugly around your head.
  - The top pad presses firmly on your head.
  - The cheek pads contact your cheeks.
  - There is no space around your brow under the inner lining.
 Test this by trying to insert your fingers.

If the helmet does not fit snugly, try on a smaller size.

5. **Check your field of vision when trying on a helmet.** Some helmets may obstruct or block your vision when looking left, right, up, or down.

**⚠ WARNING** Always make sure you can see well enough to safely operate your motorcycle.

6. **Test the helmet fit** by placing your hands on each side of the helmet. While holding your head as motionless as possible, try rotating your helmet from left to right then up and down. If you can feel the helmet padding sliding on your head, it is too big, try a size smaller. You should feel the helmet move the skin on your head and face as you try to move the helmet.

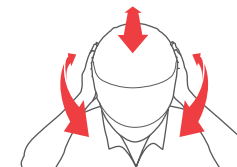

7. **Fasten the retention system (chin strap)** as tight as possible under your jaw without causing pain. There must be no slack in the strap, and the strap must be tight up against your jaw. See page 5-6.

8. **Test the retention system (chin strap)**

- Put your hands on the back of the helmet and try to push the helmet off by rotating it forward.
- Put your hands on the front of the helmet above your forehead (or on the chin guard) and try to push the helmet off by rotating backward.

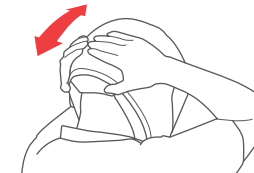

**⚠ WARNING** If helmet comes off or shifts over your eyes, try another size or another model or brand. You must be able to see the edge in your upper field of vision.

Repeat steps 3 through 8 until you find a helmet that fits your head snugly and securely.

## ⓘ Specifications

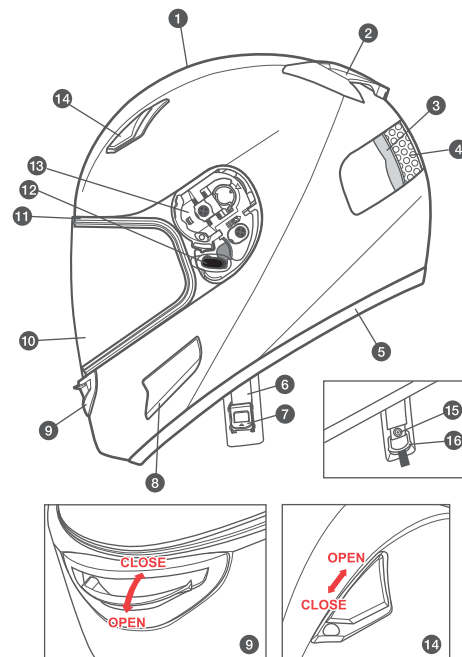

1. Outer Shell
2. Rear Venturi Exhausts
3. Impact Absorbent Liner
4. Comfort Liner
5. Rubber Edge Trim
6. Chin Strap
7. Micro Buckle
8. Side Vents
9. Front Chin Vent
10. Tool-less Shield
11. Eyepoint Gasket
12. Shield Retention Button
13. Shield Ratchet
14. Top Front Vents
15. Chin Strap Snap
16. Double "D" Ring

## Using Your Helmet Correctly

**WARNING** To reduce the risk of serious injury or death and to help prevent damage to your helmet:

- **Never adjust your helmet accessories while riding** – Only make helmet adjustments when stopped.
- **Never drop your helmet** – Dropping your helmet may crack the shell or damage the protective foam. The damage may not be visible. Your helmet is only designed for ONE impact. Refer to "Helmet Replacement" (p. 10) for more information on what to do after helmet has been dropped.
- **Never wear anything between your head and your helmet** – This may reduce the effectiveness of your helmet.
- **Never hang or hook your helmet on anything including mirror stalks or sissy bars** – Doing so may cause damage to the helmet protective foam or liner.
- **Never use insect repellent on or around your helmet** – Insect repellent may damage your helmet's shield, shell, protective foam, or other components.
- **Never expose helmet to gasoline or gasoline fumes** – Gasoline may damage your helmet's shield, shell, protective foam, or other components.
- **Never use a dark or tinted face shield at night or in low visibility conditions.**
  - If you have any questions on what other substances may damage your helmet, please contact us.
- **Always wear eye protection** – If you are not using a helmet with a face shield, always wear eye protection when riding. Always lock your face shield in place when you are riding.
- **Always be alert for sounds** – Your helmet may impair your hearing. However, your helmet is not a form of hearing protection.
- **Always store your helmet in its helmet bag** when not in use to help reduce accidental surface damage.

**WARNING** To reduce the risk of serious injury or death, always use your helmet correctly.

### Inspect your helmet

To ensure that your helmet is in the best condition to maximize your protection, always inspect your helmet for damage before riding:

- **Check the shield and shield ratchet** – re-tighten shield ratchet screws if necessary. Be sure not to over-tighten any screws. Plastic base plate screws can break and plastic screws can strip the screw sleeves if over-tightened.
- **Check for helmet damage.** If your helmet is damaged or cracked, stop using it immediately. See "Helmet Replacement" (p. 10) section for further information. If your helmet has been dropped, you may not be able to see the damage.
- **Check for worn or damaged parts.** Plastic components may wear out over time. If you find worn or damaged parts, replace them or purchase a new helmet. See "Replacement Parts" (p. 9) for information on parts replacement.

**WARNING** If parts fall off while riding, your vision may be blocked which could cause an accident.

- **Check the retention system (chin strap) for damage.** If it is frayed or ripped, replace the helmet.
- **Check that all pads are in place.** Both of the cheek pads and the crown pads must be in place.

### Check Your Face Shield

If your face shield is scratched or damaged it may reduce the visibility—replace if necessary. Always make sure you can see well enough to safely operate your motorcycle.

### Fasten the Retention System

Fasten the retention system (chin strap) as tight as possible under your jaw without causing pain. There must be no slack in the strap, and the strap must be snug up against your jaw. If the retention system is not tight, your helmet may become dislodged or knocked off in an accident.

**WARNING** Do not rely on the snap to secure the helmet. The snap is provided only to prevent the strap from flapping in the air. Fasten the retention system only in the following manner:

#### Micro Buckle

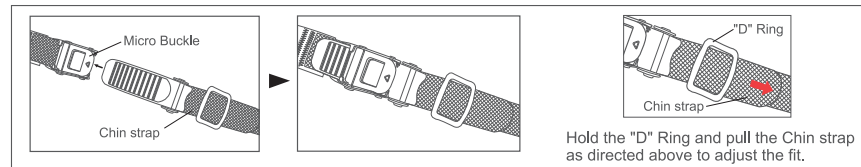

#### Double "D" Ring

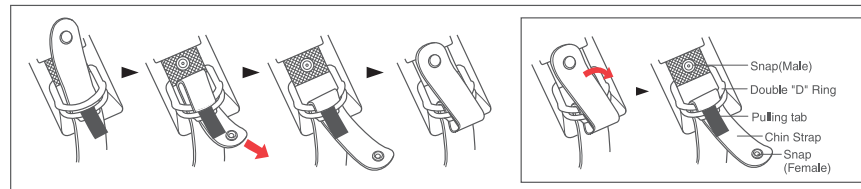

## Maintaining Your Helmet Correctly

### Shell Cleaning

**WARNING** Only use the approved methods listed below to clean the helmet. Using other unapproved chemicals or methods may damage the helmet shell or lining. A damaged helmet may increase your risk of serious injury or death in an accident.

**Glossy Finish.** HJC recommends cleaning your helmet with products designed for automotive cleaning and polishing. All HJC helmets are finished with an automotive type base coat/clear coat finish. Rubbing compounds can be used for deep cleaning to remove many scratches and scuffs. Follow the product's instructions diligently. Over polishing with rubbing compounds can cause light abrasions which may dull the finish of your helmet. Stickers and decals will leave adhesive residue when removed. To remove the adhesive residue, use alcohol swabs. Be certain to immediately wipe away the excess liquid and clean the area with soap and water once the adhesive residue is removed. Do not use excessive pressure while rubbing when attempting to remove the adhesive residue, instead use multiple light treatments.

**Non-Glossy Finish.** For our flat finish (non-glossy) helmets, we recommend using warm water and mild soap. Use multiple treatments for heavier dirt. Do not use excessive pressure or rubbing compounds while cleaning the surface as a "glossy" effect could be created, ruining the flat finish appearance.

### Interior Cleaning

Although we recommend changing a helmet every 3 to 5 years, the accumulation of sweat, humidity, and dirt can deteriorate the fabric and stitching and this may cause odor. To wash HJC removable pads, HJC recommends regular machine washing and air drying. For non-removable interiors, HJC recommends using bacteria and mildew eliminating products such as "Helmet Fresh".

### Vent Cleaning

Dirt and debris can find its way into the venting of your HJC helmet. Compressed air cans used for cleaning computer keyboards may be used to blow the debris from the ventilation system. It is recommended that you remove any removable pads before doing this process.

## Shield Removal

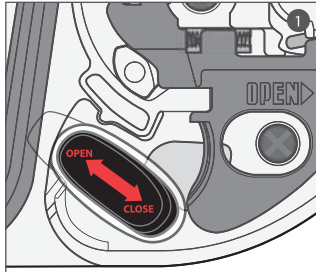

1. Move the shield retention button to the open position.

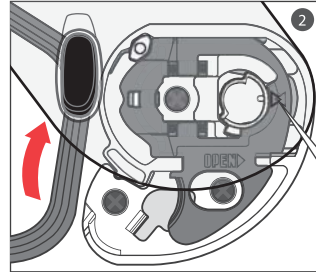

2. Open Shield to the maximum open position.

When the shield is opened to its maximum open position, the arrow on the shield should line up with the arrow on the handle-locker.

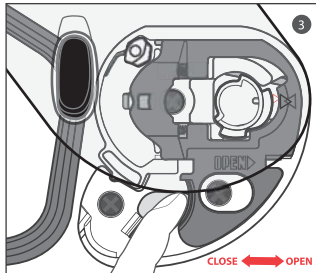
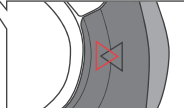

3. Move the handle-locker to the open position.

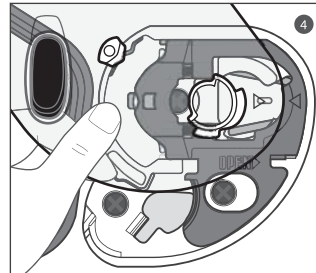

4. Shield will be automatically released out of base ratchet mechanism.

## Shield Installation

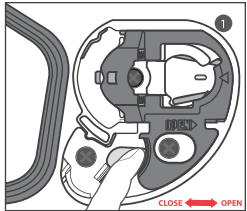

1. Ensure that the handle-locker is in the open position.



2. Align and insert the top of the shield guide into the plate-gear guide.

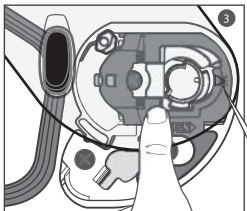
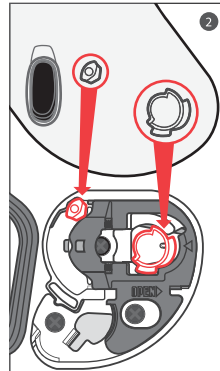

3. With the guides properly aligned, press the lower section of the shield into the Plate-Gear mechanism. The locking tab should pop into position, locking the shield into place.



## ⚠️WARNING

Always check to make sure helmet pads are installed before using the helmet. A helmet with missing or improperly installed pads may increase your risk of serious injury or death in an accident.

## Cheek Pad Removal

There are 3 snaps holding the cheek pad in place.

1. Gently pry the cheek pad away from the interior, releasing the snaps.
2. Grasp the cheek pad near its center and gently pull it free from the chin strap.

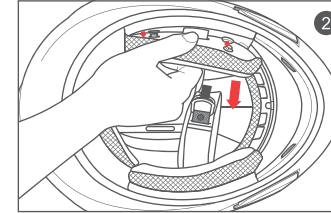
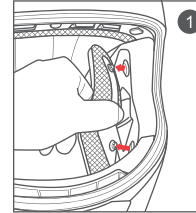

## Cheek Pad Installation

1. Feed the chin strap through the opening in the cheek pad.
2. Align 3 cheek pad snaps, and press the snaps together, starting with either of the two rear snaps first.

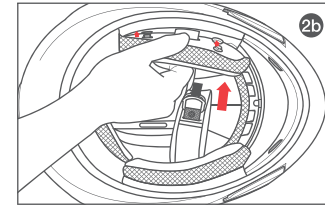
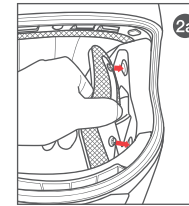
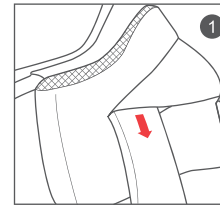

## Crown Pad Removal

The crown pad area is composed of the crown pad, a front plastic snap mount system, and a rear pad plate which is inserted between the shell and impact absorbent liner.

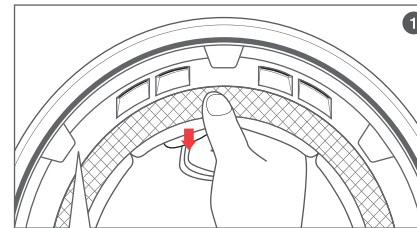

1. Grasp the crown pad fabric as close as possible to its plastic base and pull/pry away from the helmet. Notice how the crown pad plastic section aligns with the shell plastic sleeve. This will help orient you with the reinstallation.

2. Repeat same at rear.

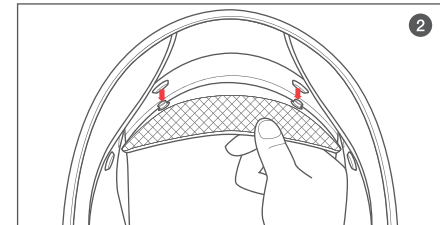
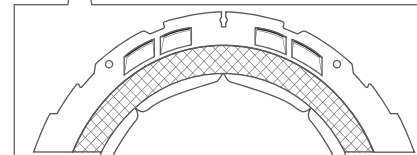



## Crown Pad Installation

1. Install the front section first by aligning the plastic shell base and the crown pad plastic sleeve, ensuring that the center and side holes are properly aligned. Press the crown pad plastic sleeve (center portion) into the center of the channel which is built into the plastic shell base, working your way outward to each side.
2. Align and snap the two rear snaps into place.

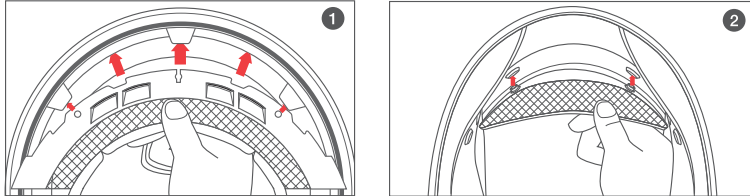

## Replacement Parts

**⚠ WARNING** Use of replacement parts not manufactured by HJC may increase your risk of serious injury or death in an accident. Only use HJC parts that are specifically designed to work with this helmet.

## Do Not Modify Your Helmet

Your HJC helmet is designed to meet ECE R 22-05 standard. Contact HJC Europe for more information about the ECE R 22-05 standard.

Modifying your helmet may increase your risk of serious injury or death in an accident. Do not modify your HJC helmet. Modifications include the following:

- drilling holes;
- cutting shell, liner, or strap;
- modifying the retention system, including adding a chin cup;
- removing parts;
- painting; and
- attaching accessories that are not manufactured by HJC for this helmet.

If you have questions about modifications, please contact HJC Europe. See back cover for contact information.

## ◉ Storing Your Helmet Correctly

**⚠ WARNING** An improperly stored helmet can become damaged and may increase your risk of serious injury or death in an accident. You should:

- Store helmet in a cool and dry place,
- Keep helmet away from pets and other animals,
- Keep helmet away from heat in excess of 50°C and do not set on or near hot surfaces.
- When helmets left out in the sun for extended periods of time, it may fade overtime.

## ◉ Helmet Replacement

**⚠ WARNING** Although your HJC Helmet is constructed with the best materials available to offer a long-lasting product, it will eventually need to be replaced. Immediately replace your helmet if:

- It has suffered an impact. Your helmet is only designed for ONE impact. An impact may fracture the outer shell or compress the impact absorbing liner. You may not be able to detect this damage. Any impact in a crash or a drop from as low as 4 feet is enough to damage your helmet.
- The shell, lining, or retention system is damaged. The helmet shell, the impact absorbing lining, and the retention system must be in good condition to provide you with the most protection.

Even if your helmet has not been damaged, it needs to be replaced every 3 to 5 years depending on how much you use it. Over time, UV rays and adhesive and component aging will damage your helmet. Wearing a damaged helmet may increase your risk of serious injury or death in an accident.

If you are unsure if you need to replace your helmet, contact HJC Europe before using your helmet again.

## Helmet Disposal

**⚠ WARNING** If you buy a new helmet, destroy the old one to ensure it cannot be reused. Do not sell or give away your old helmet, even if it has not been damaged. Over time the protective foam in the helmet will adjust to the contours of your head. If someone else uses this helmet it will not provide them with as much protection.

## ◉ Warranty

HJC hereby extends a limited warranty to the purchaser of a HJC helmet that the helmet is free of defects in materials and workmanship.

## Coverage

This warranty is applicable to manufacturer's defects only and is good up to one year from the date of purchase. It does not apply to any problems arising out of wearer's misuse, negligence, modifications, accidents, etc.

## Disclaimer

Any warranty of merchantability and any implied warranty are hereby expressly disclaimed. In addition, HJC shall not be liable for any consequential damages.

## Procedure

In order to receive warranty, please take your helmet, your receipt showing the date of purchase, and a brief memo that includes a description of the problem, your name, and phone number to the authorized HJC dealer from which you purchased your helmet.